



Technical Data

Specification & Capacities



JFS45

S.N: _____



55,4kW/74,3HP



13 kW/17,4HP



0 – 28,2m



WINCH: 6000kg
HOOK : 15500kg



EN 12999

[m] [kg]



Via Campardone, 1
31014 Colle Umberto – Italy
Tel. +39 0438 1710083
Mail: info@jekko.it
Web: www.jekko.it

Date	Jun. 27 th 2018
REV.	Rev. 3

JF545 - OVERALL DIMENSIONS

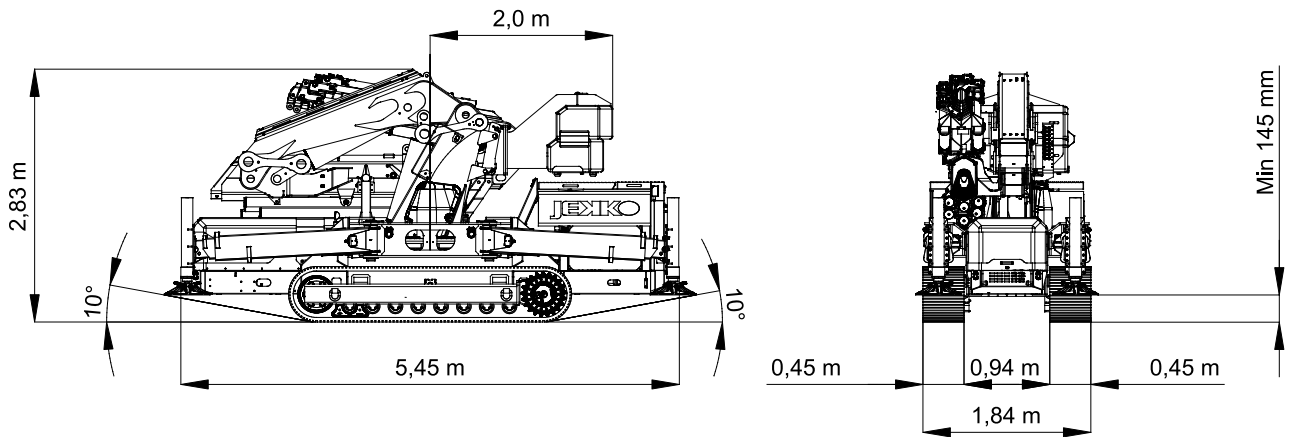

JF545 – STABILIZATION AREA

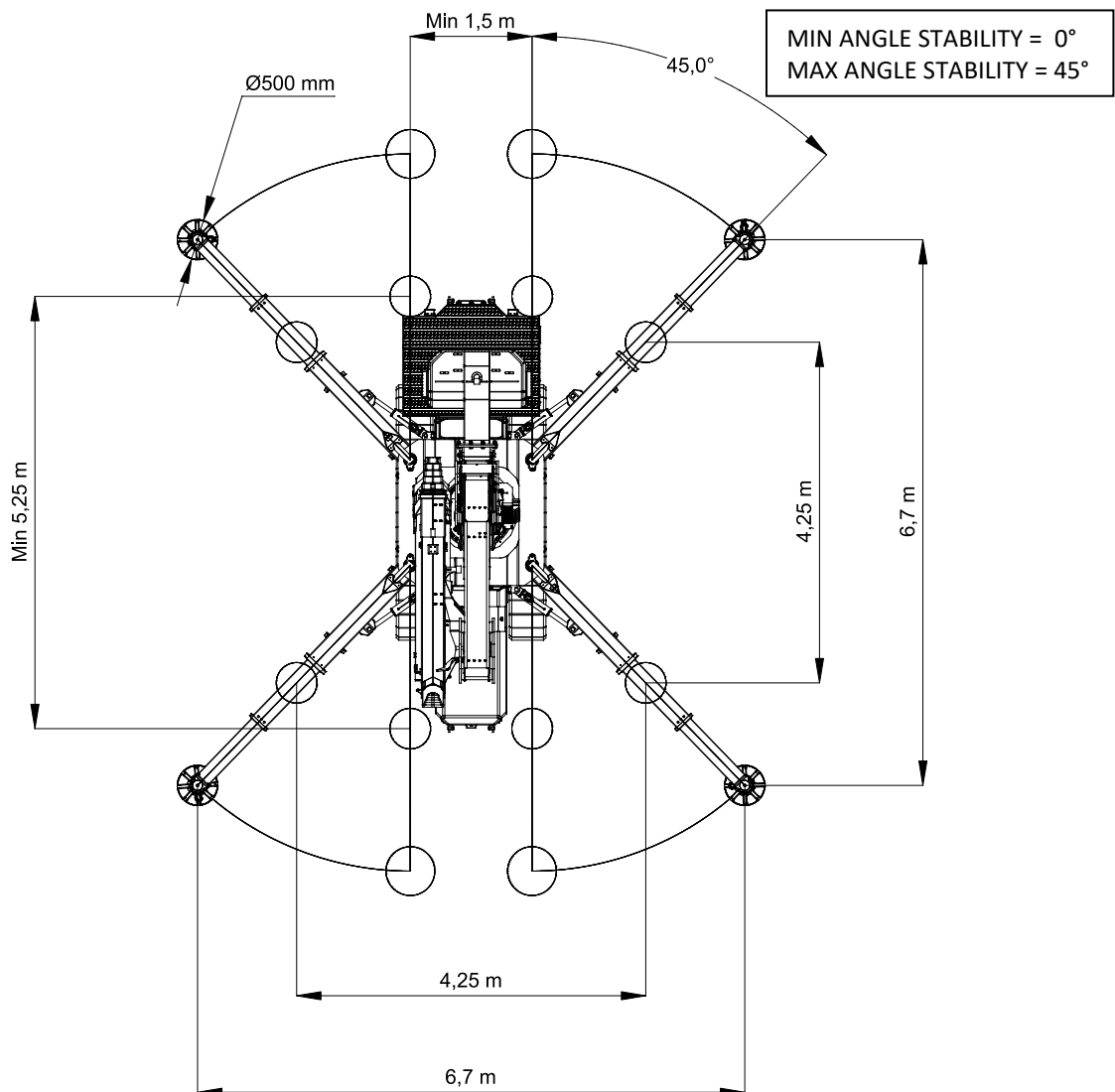

JF545 – STABILIZATION CHART*

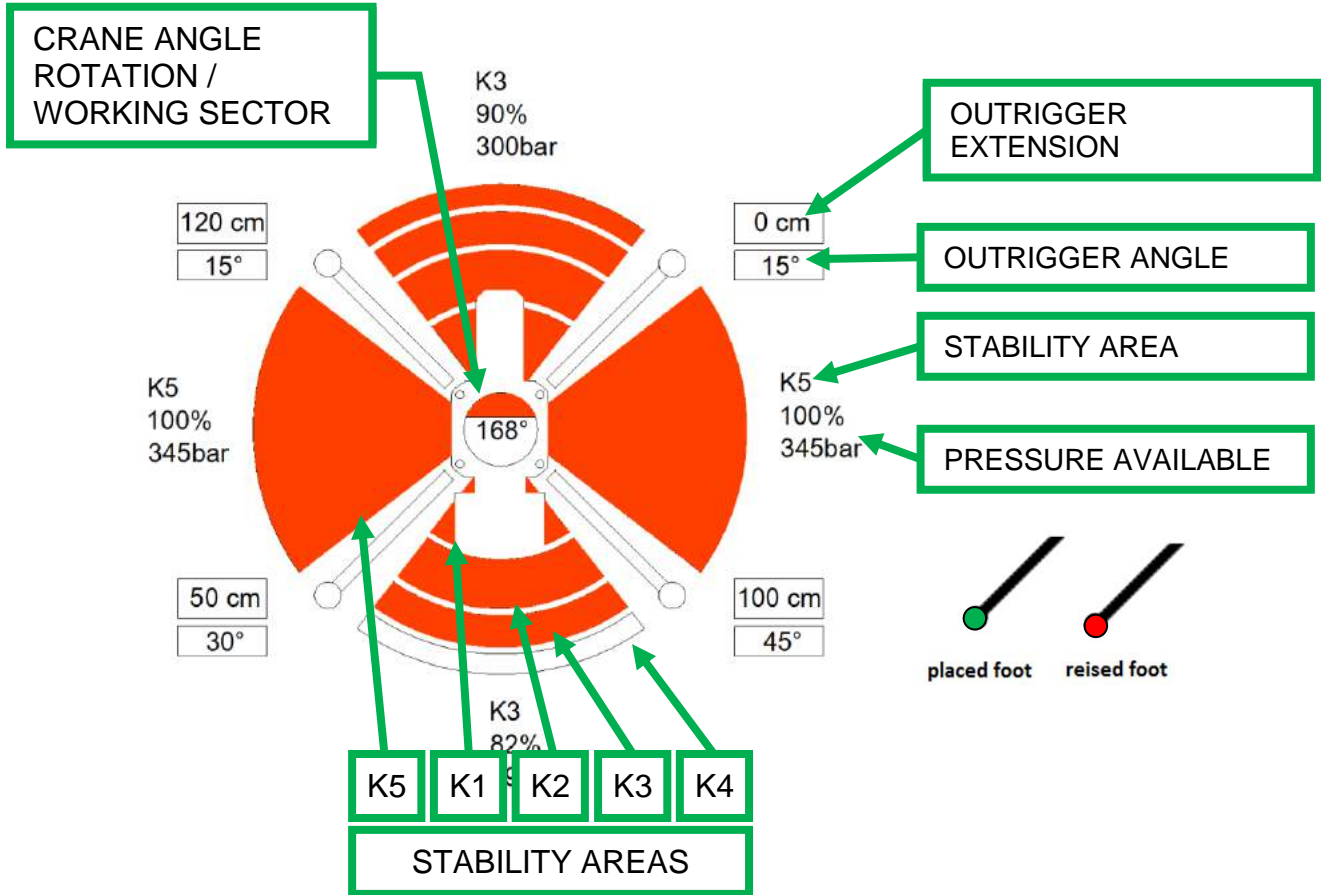

*The division in 4 areas is a schematic simplification: software adapts level pressure continuously

JF545 – STABILIZATION ADJUSTMENT

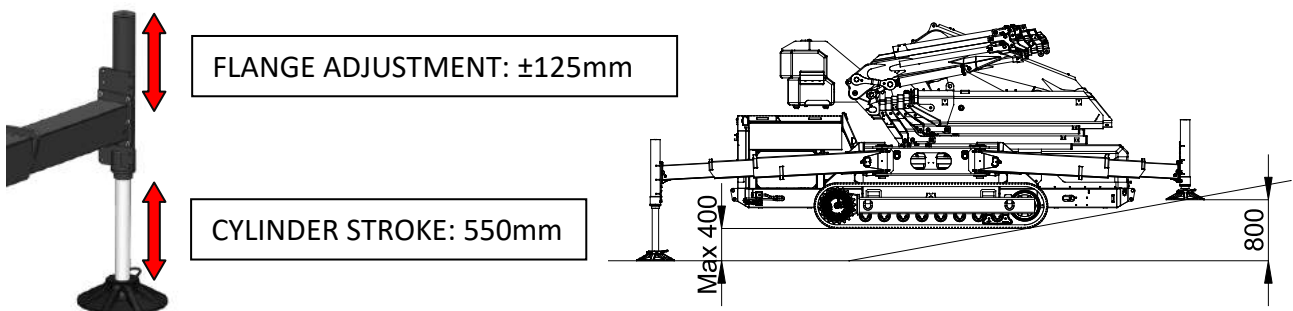



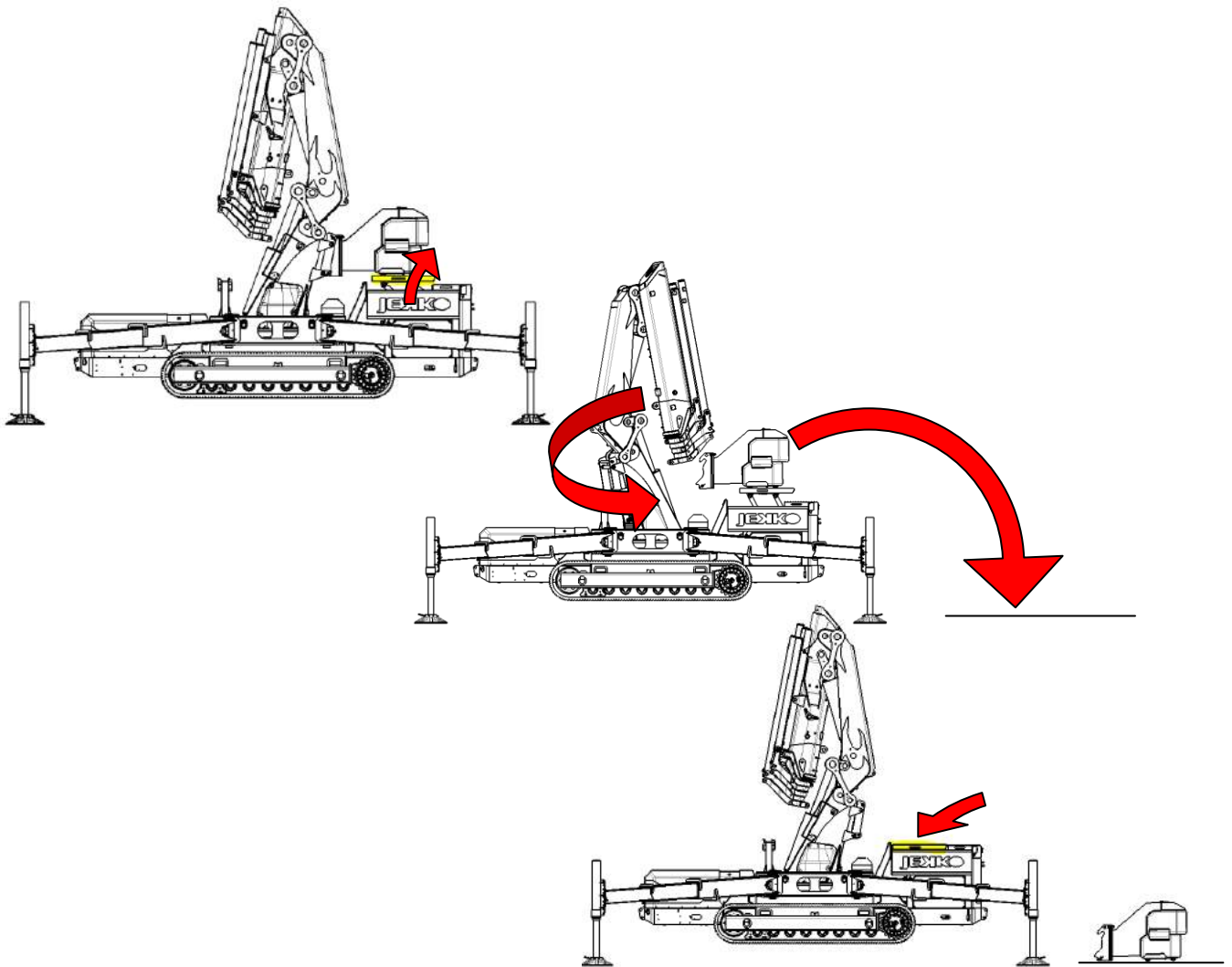



JF545 – COUNTERWEIGHT REMOVAL

















JFS45

		Name / version	kg ¹
			JF-545
	JF-545	3500	
	BWF2000-I	190	
	SINGLE FALL	47	
	DOUBLE FALL	58	
	TRIPLE FALL	57	
	JIB SINGLE FALL	75	
	POWERPACK	80	
	L426	1200	
	LOW MARKING PADS	300 (3,25 x 92)	
	Ø500	30	

WEIGHTS

- 1: Dry weight
- 2: Engine continuously working limit
- 3: Static lifting

ENGINE		KUBOTA V3307-CR-TE4B	
		55,4kW / 74HP	
		DIESEL	
		L	70
ELECTRIC		400V-3F 13kW 17,4HP	
	HYDRAULIC		ISO 6743-4:HVLP with VG46 viscosity class
		Working temp	<70°C
		L	200
MOVEMENTS		km/h	2,5
		20° (36%) ²	
		kg/cm ²	0,85
		kg	11250
		80°	
		s	Pri: 37 Sec: 39
		360°	
		rpm	1,0
		m	28,2
		s	42

HOIST PERFORMANCE	Winch	Layer	Max line pull	Standard rope speed	Highest rope speed	
			kg	m/min	m/min	
		1	2600 ¹	36,5	N/A	
		2	2400 ¹	40,0	N/A	
		3	2200 ¹	43,5	N/A	
	4	2040 ¹	47	N/A		
	Rope	Wire rope	Ø	Total lenght		Max load
			mm	m		kg
		Right lang lay	12	60		2400
	Hook block	Load	N° of		Block type	
		kg	Sheaves	Lines		
		6000	2	3		Multiple fall block
		3500	1	2		
		2000	-	1		Single fall block

¹:LMI limited at 2000 kg

JF545RA.2.26 with HOOK

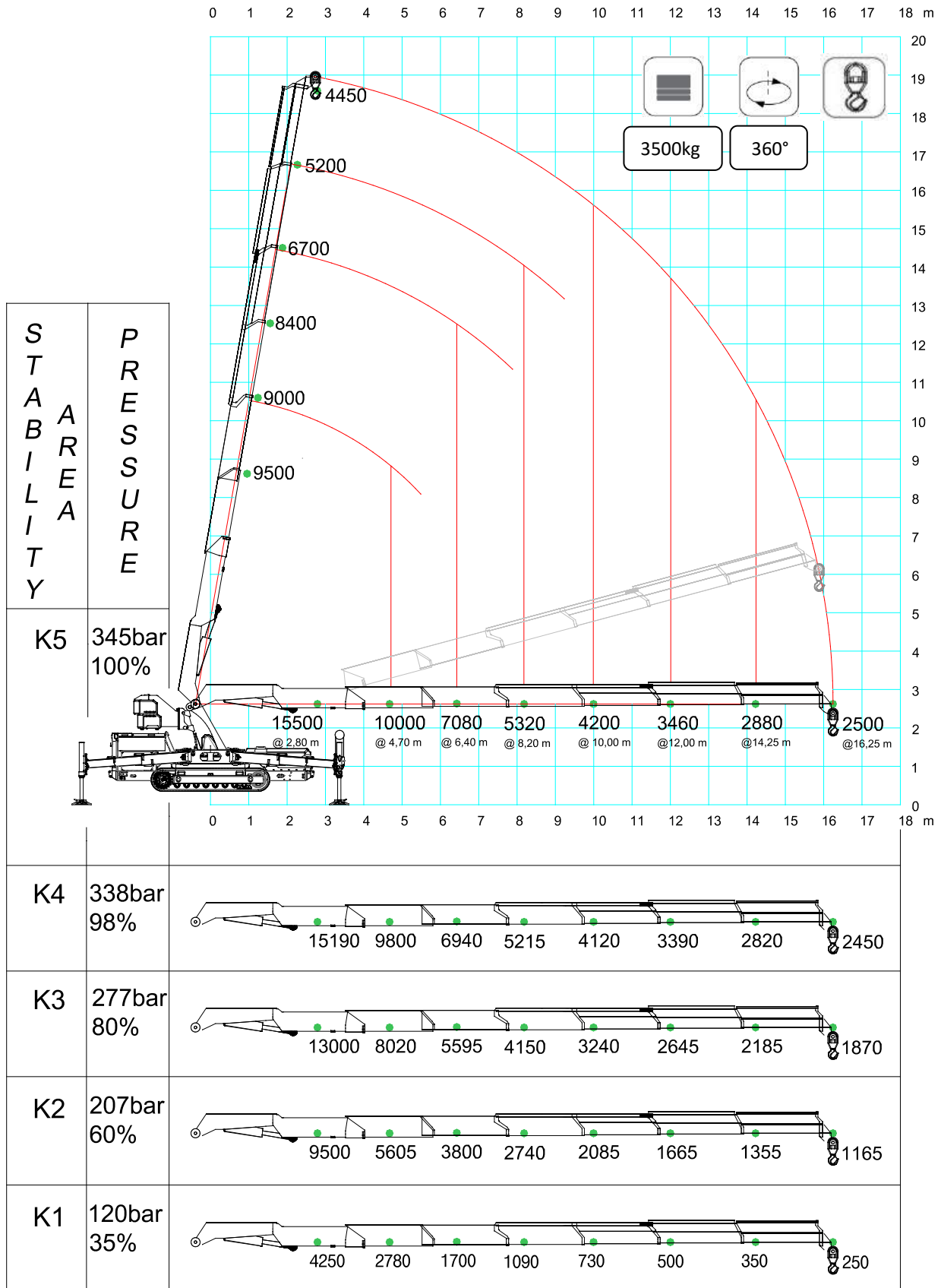

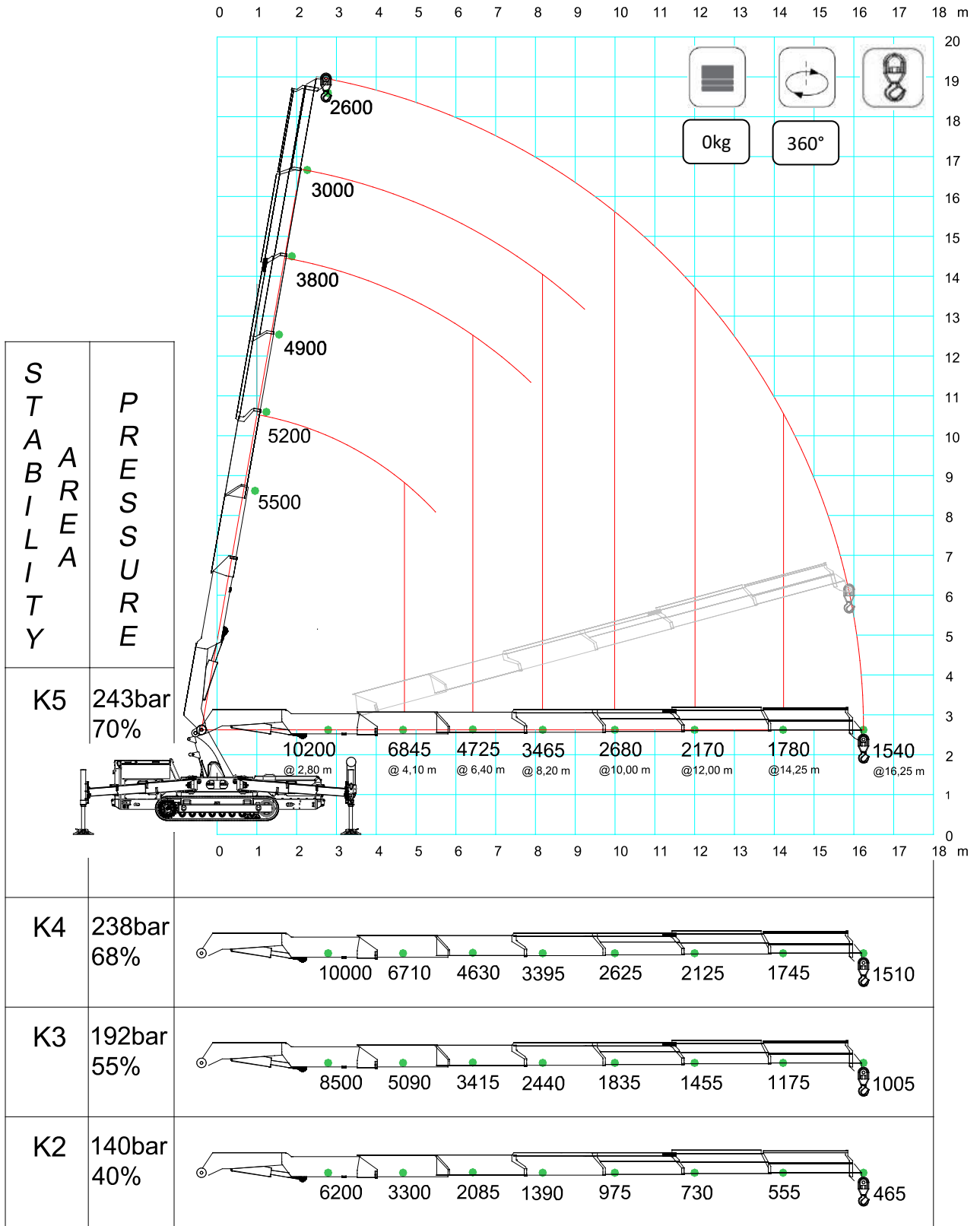

JF545RA.2.26 with PULLEY

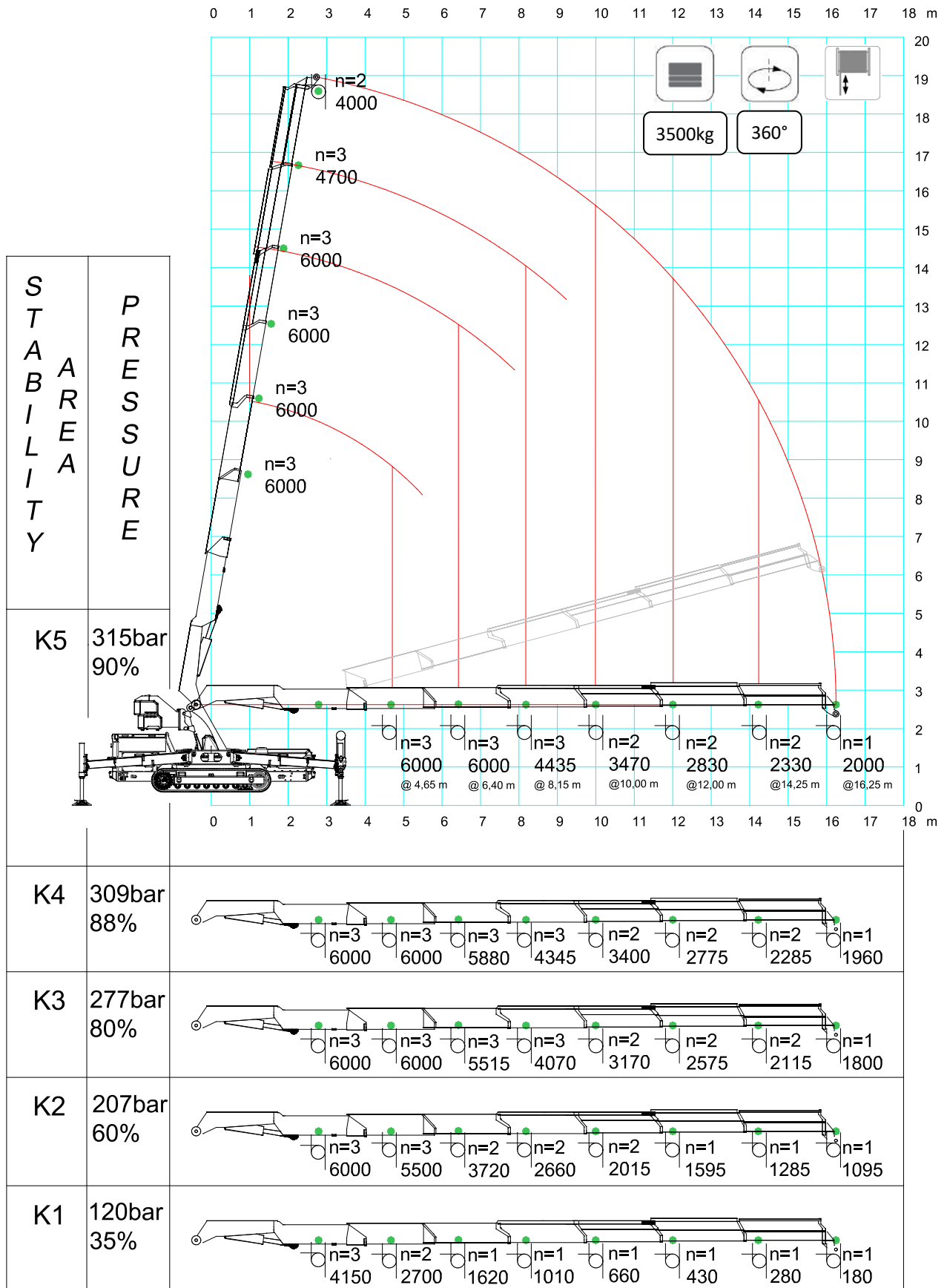

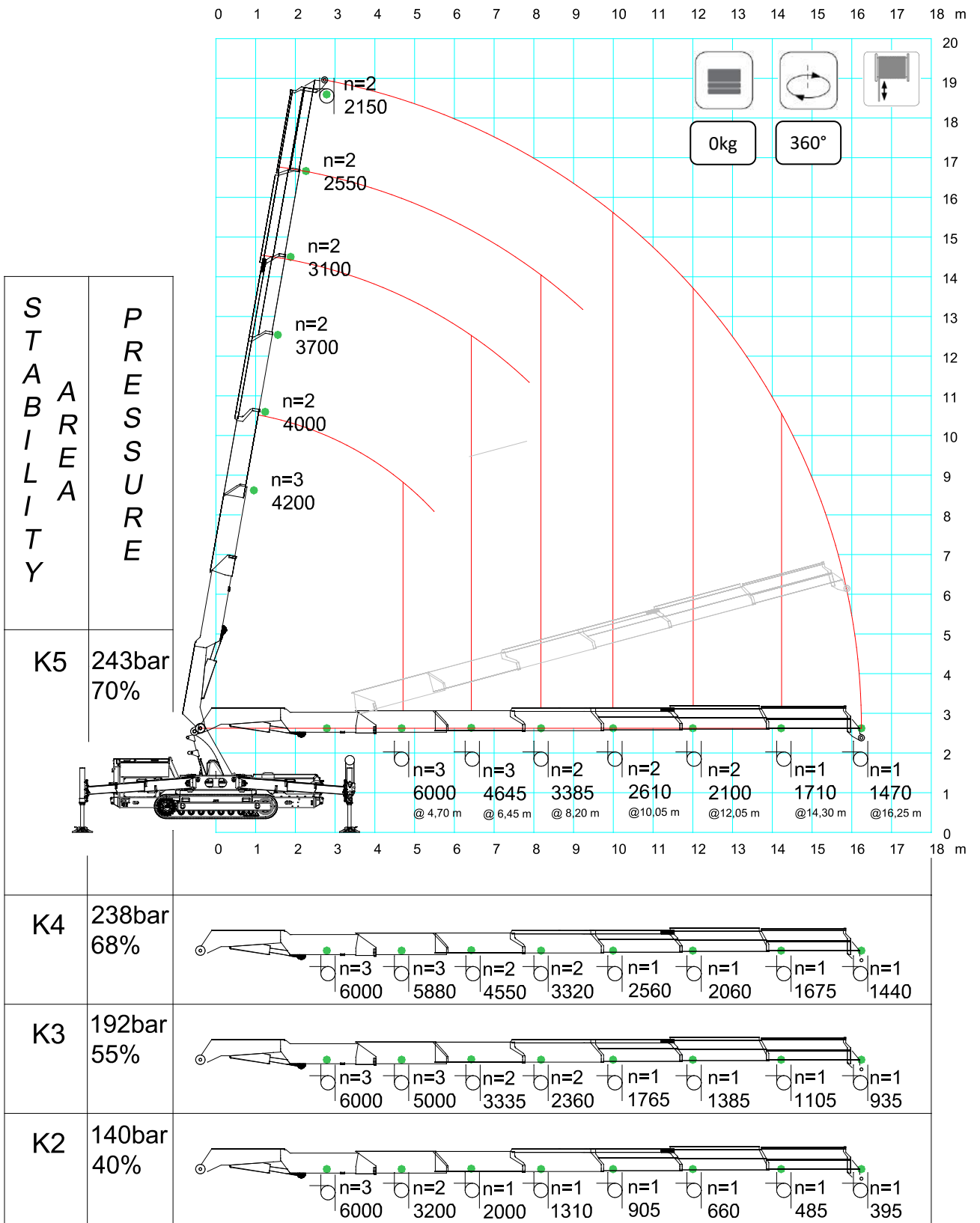

F545RA.2.26 + L426 with HOOK

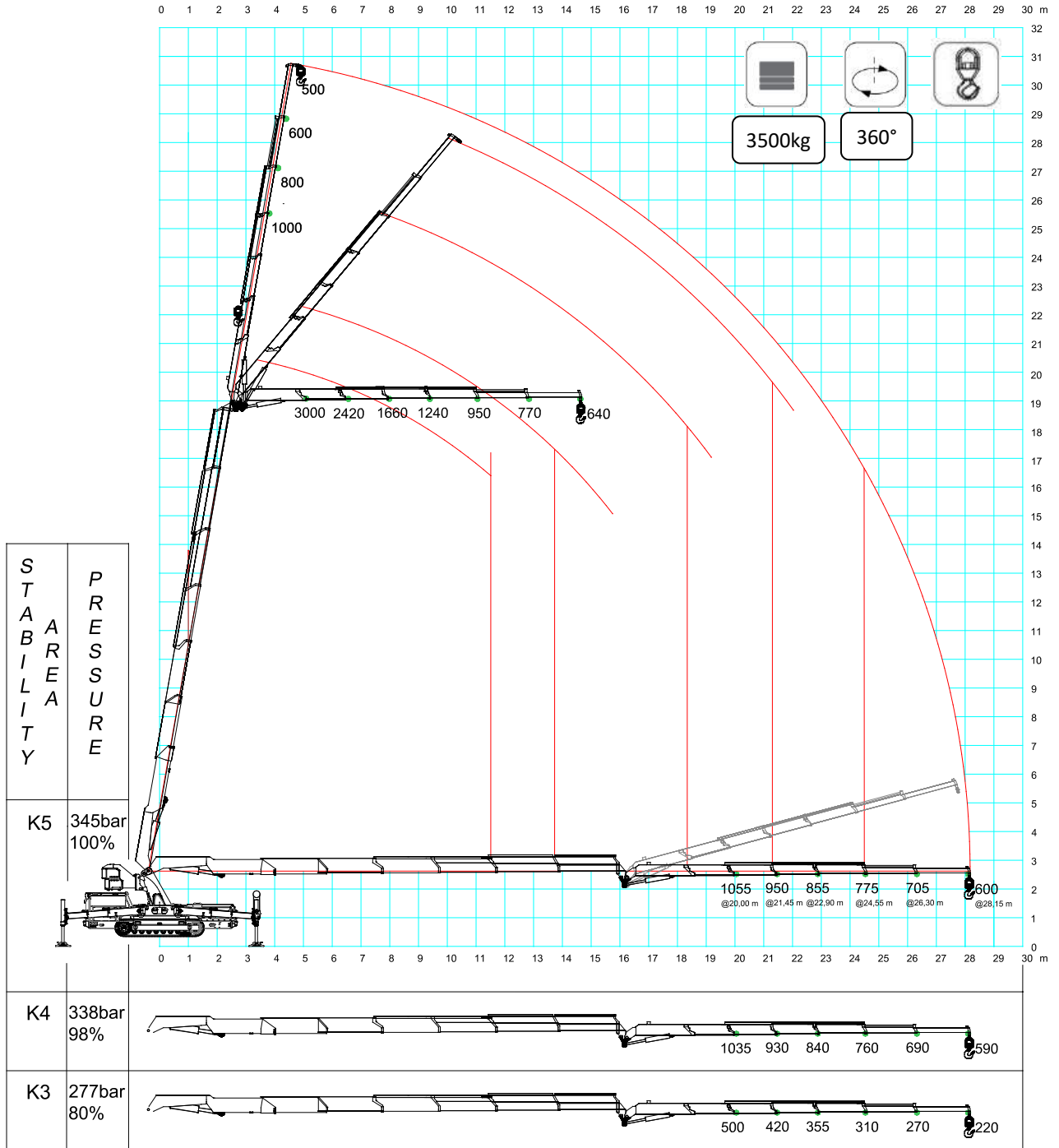

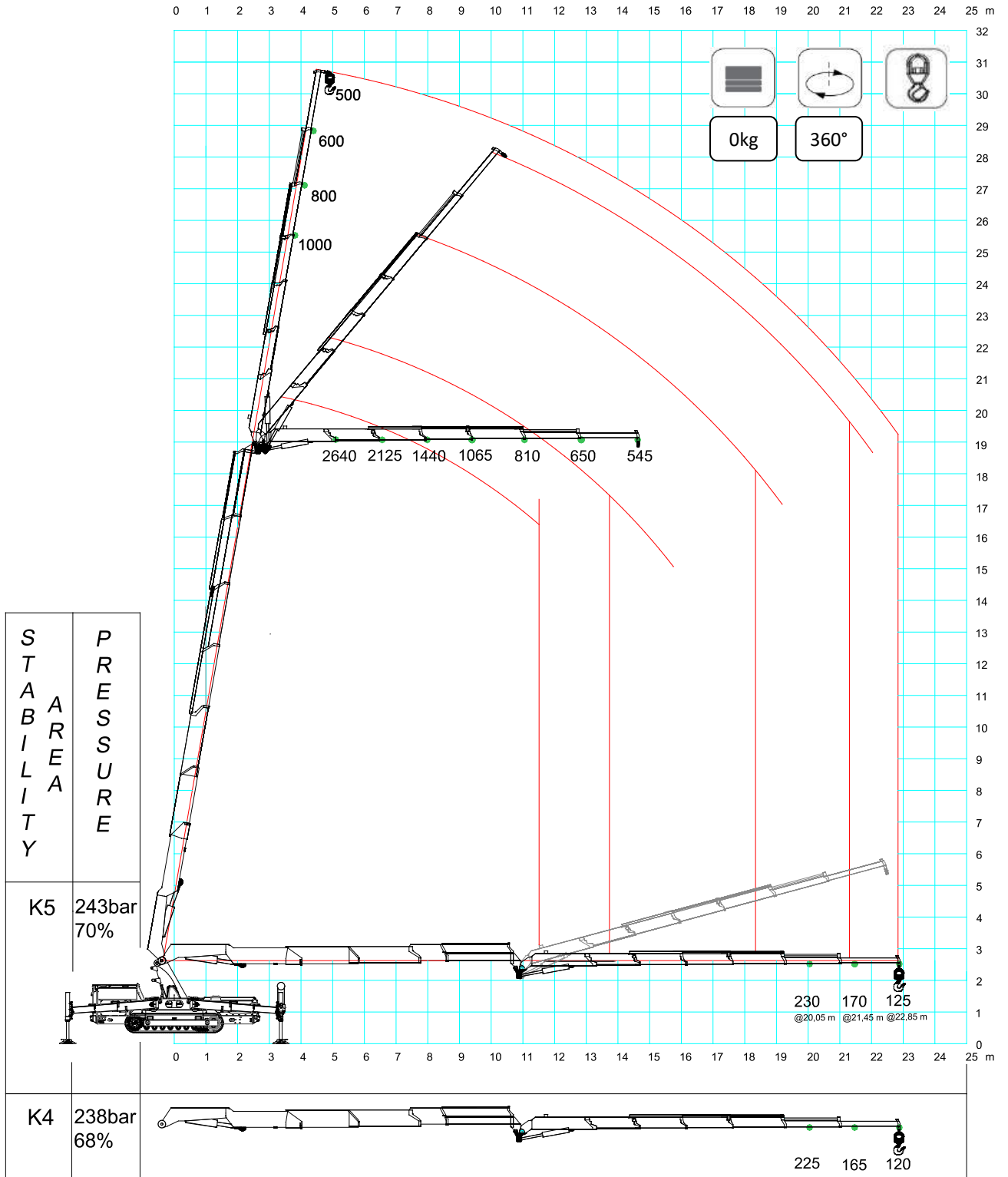

JF545RA.2.26 + L426 with PULLEY

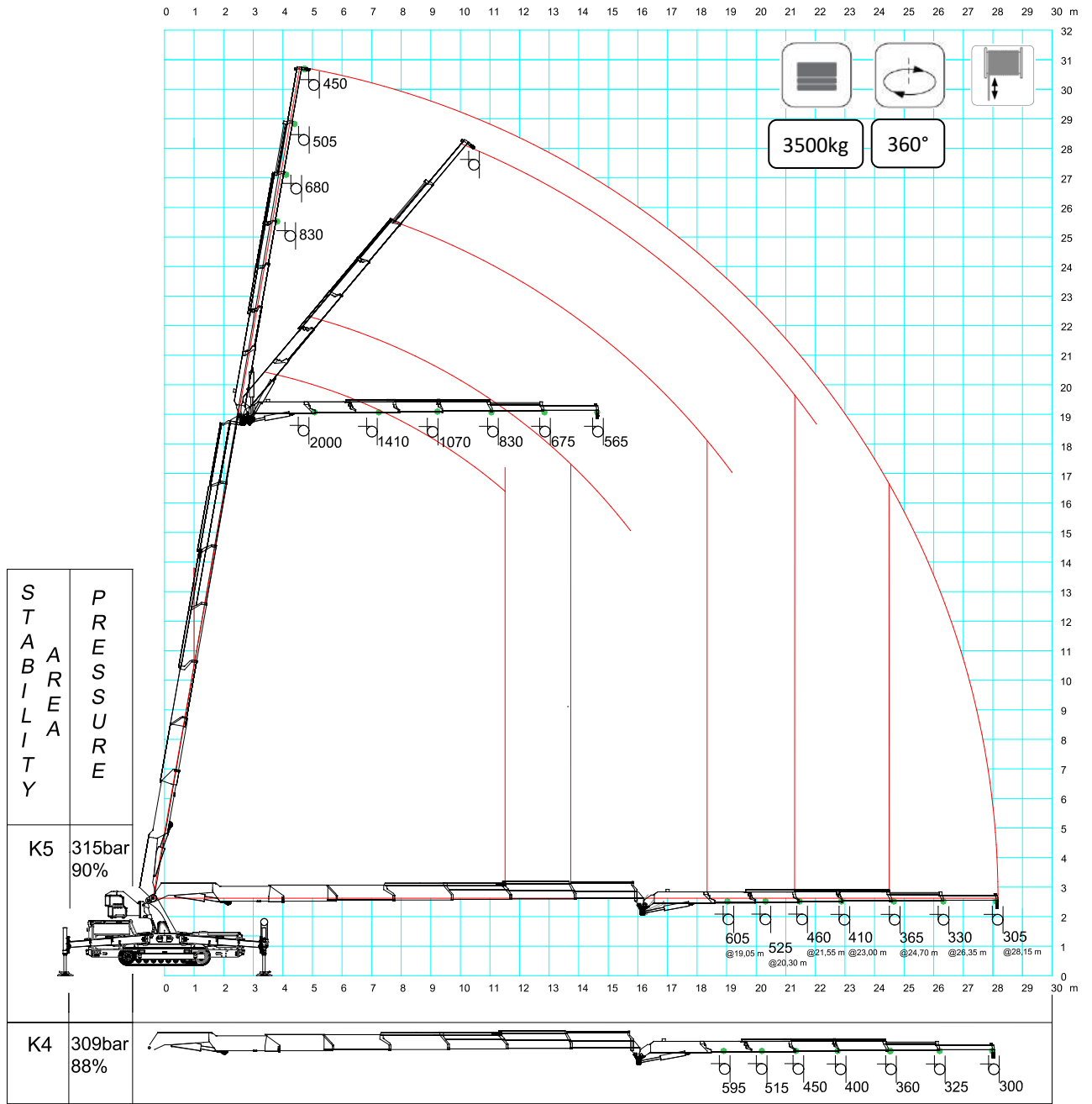

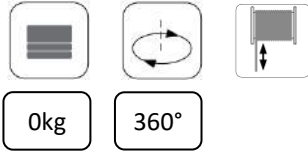

0 1 2 3 4 5 6 7 8 9 10 11 12 13 14 15 16 17 m

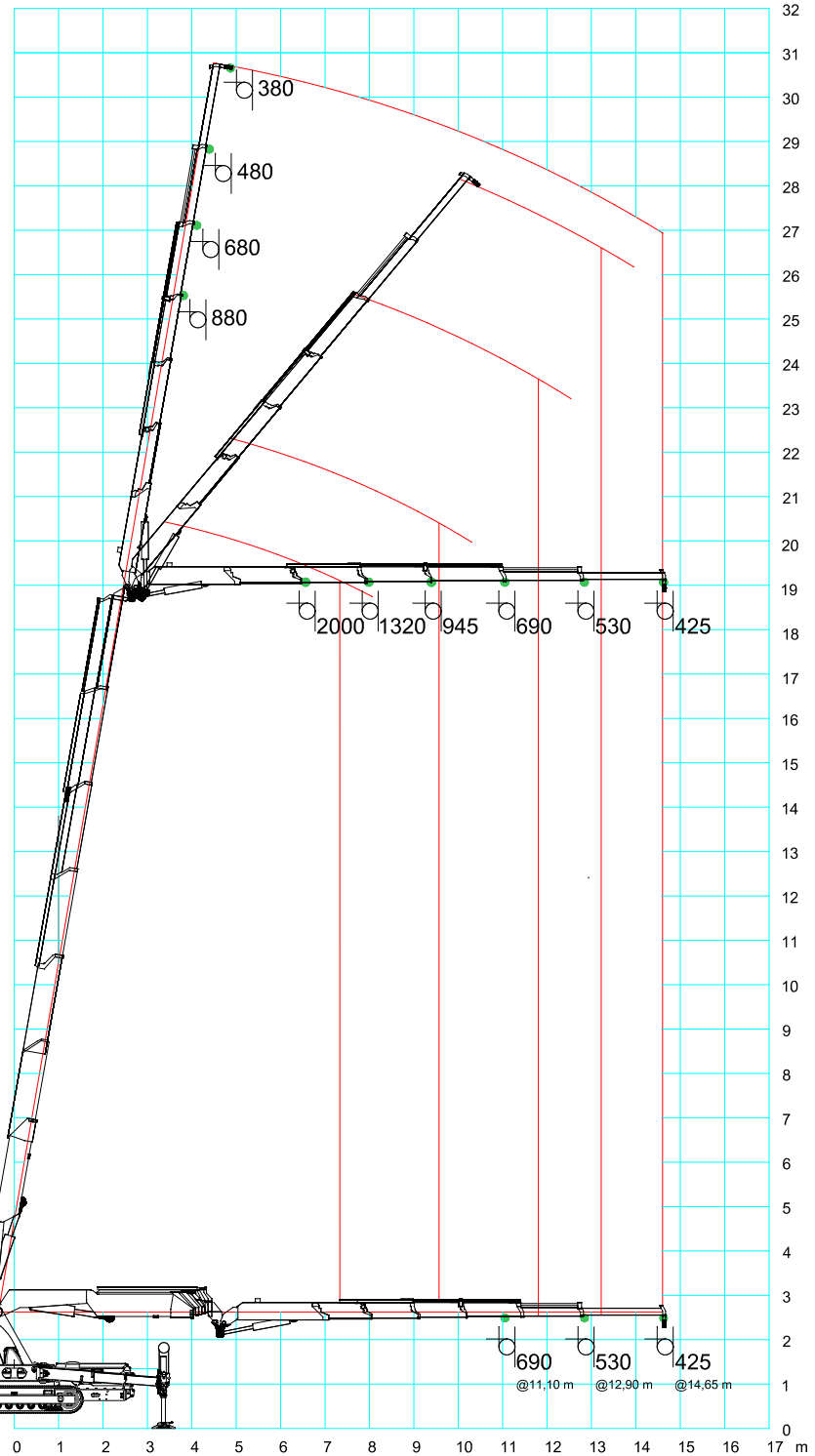

STABILITY	PRESSURE
K5	345bar 100%
K4	338bar 98%

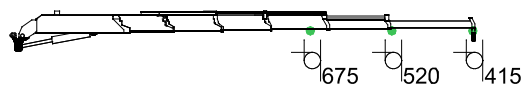

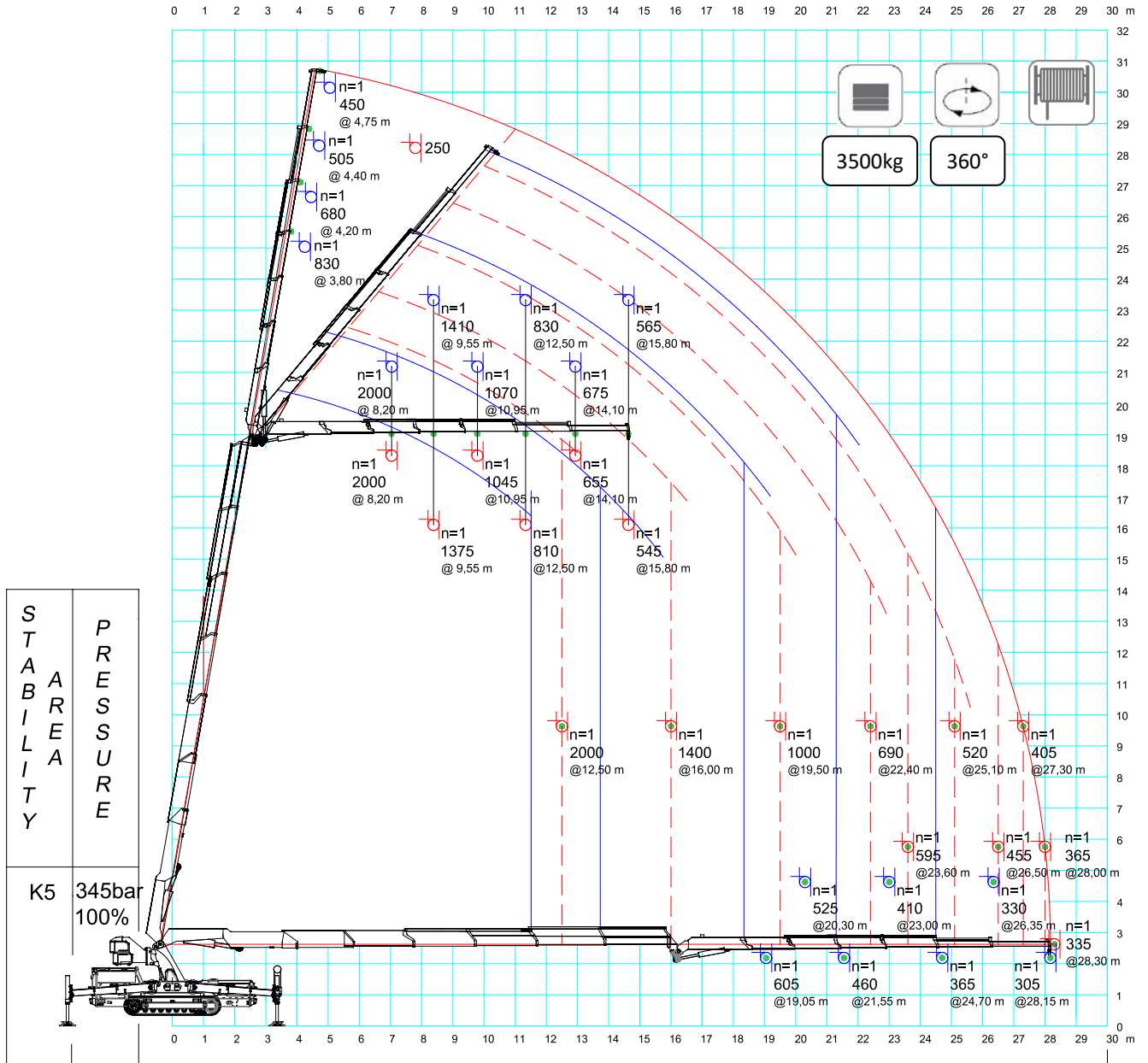

- - - - - Static lifting capacity: LMI stop position.
- Dynamic lifting capacity: all crane function are possible.

MAN BASKET

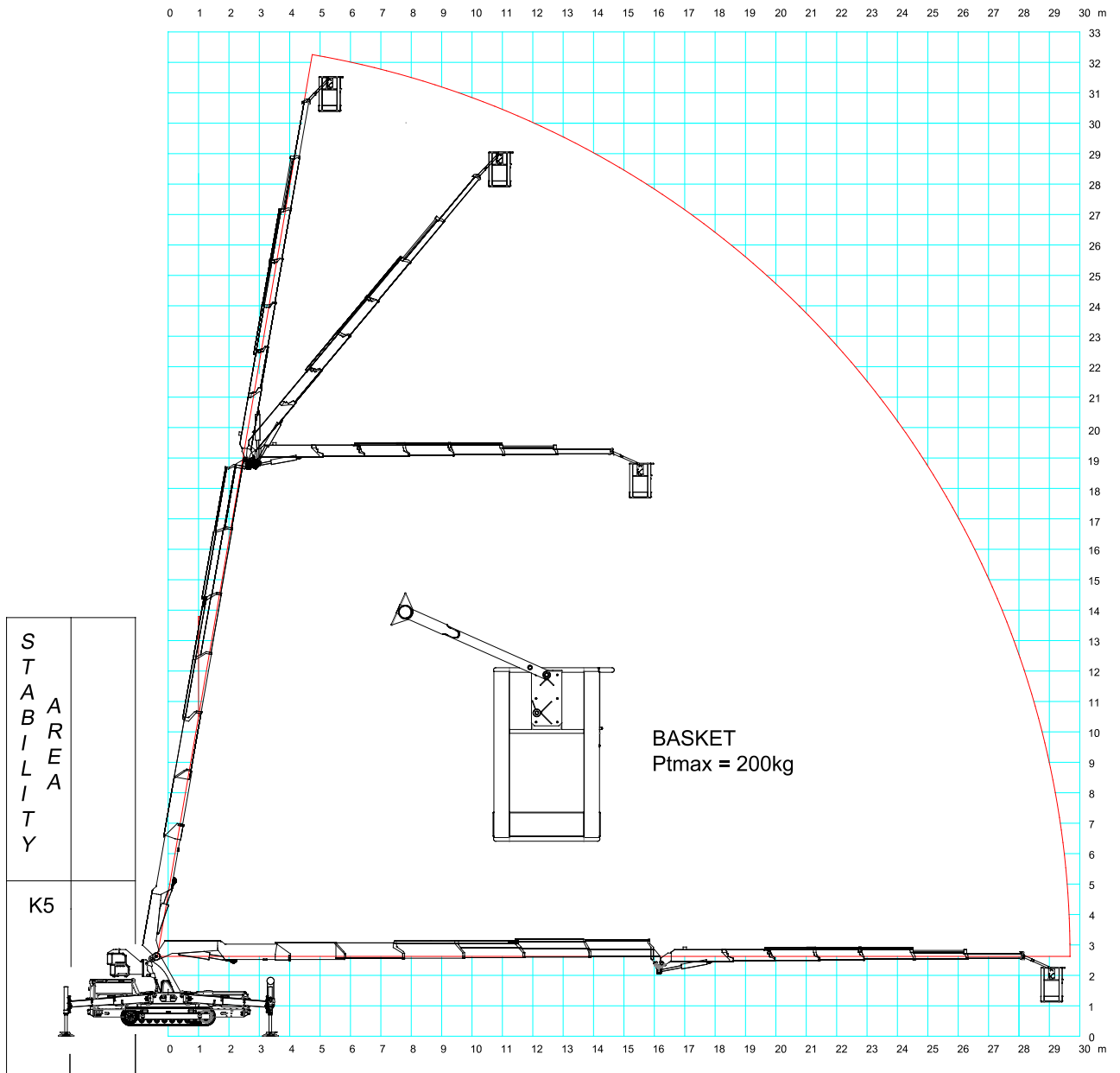

WORKMAN PLATFORM

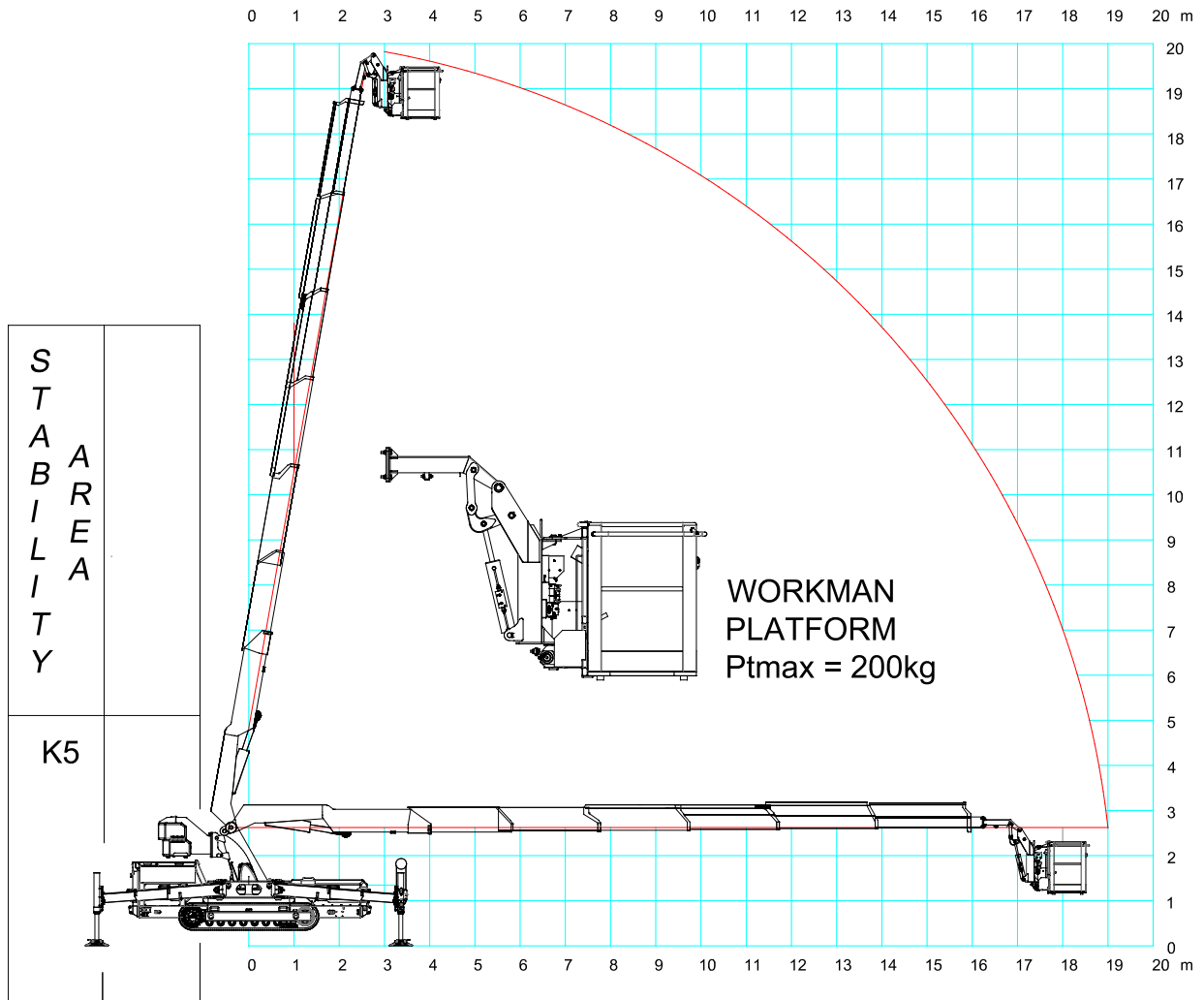

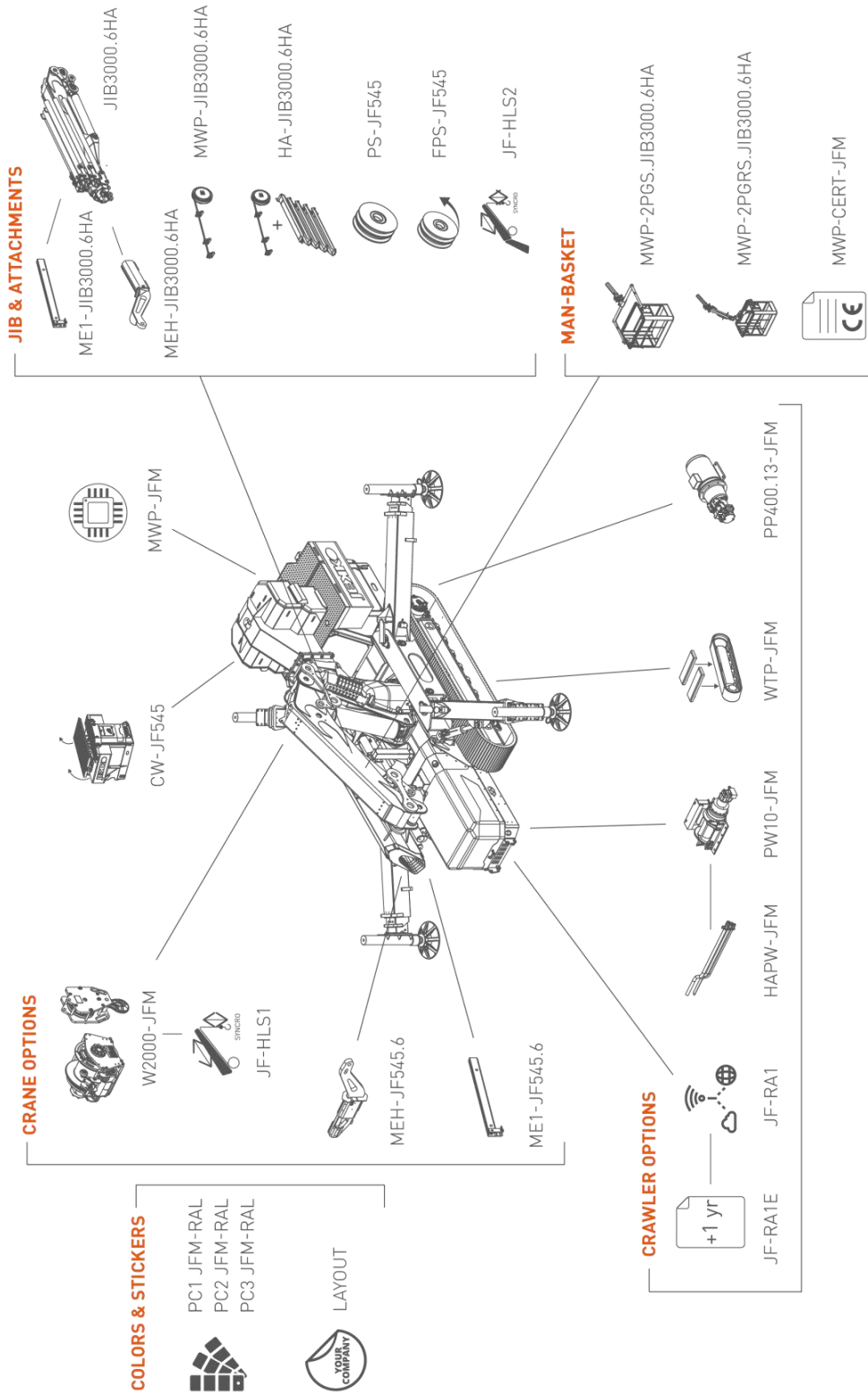

	STANDARD	PC-01	PC-11
Boom, covers and outriggers	RAL2004	RAL_____	RAL_____
Chassis, frames and tanks	RAL7021	RAL7021	RAL_____

ACCESSORIES FEATURES

JIB L426

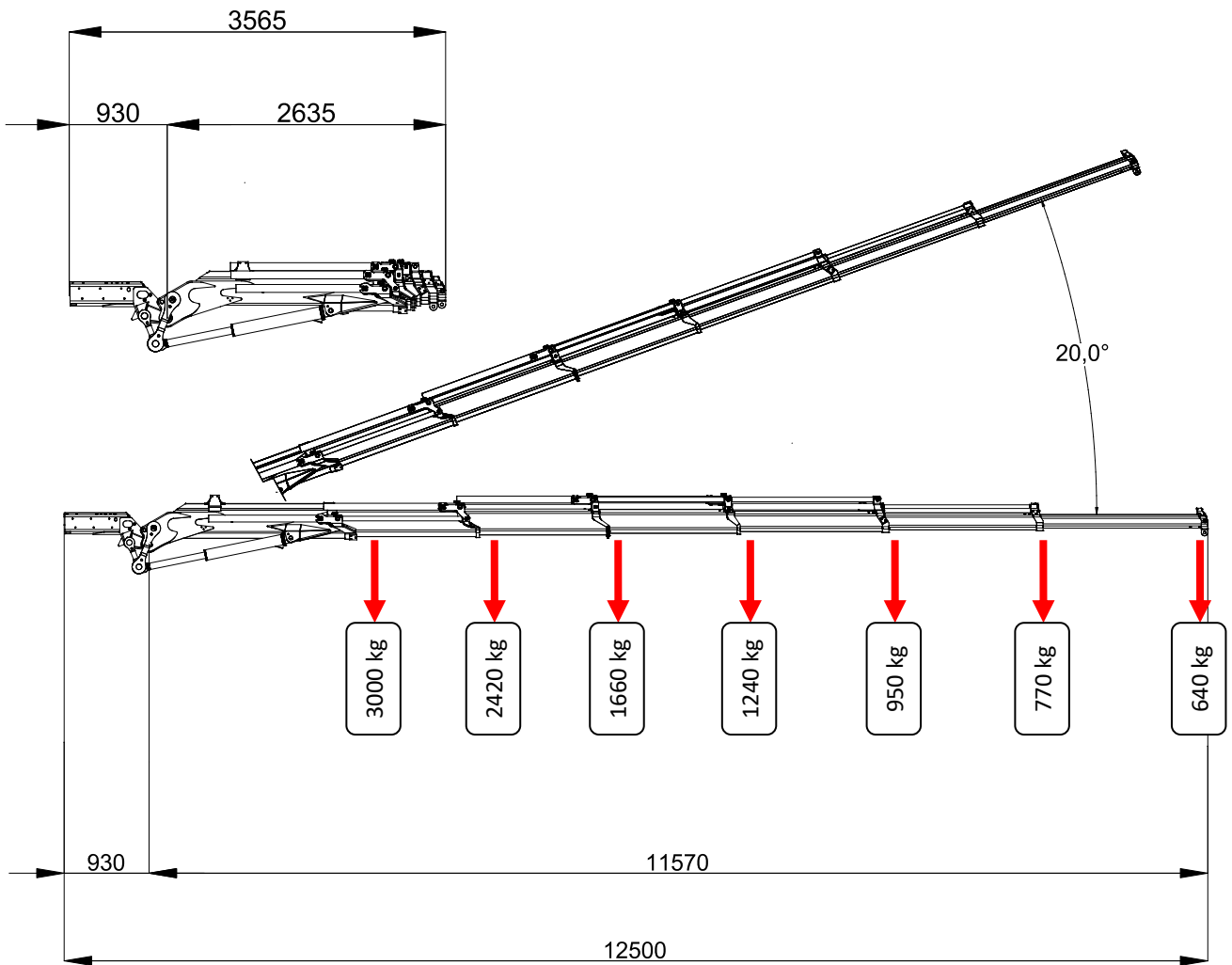

LOW MARKING PADS

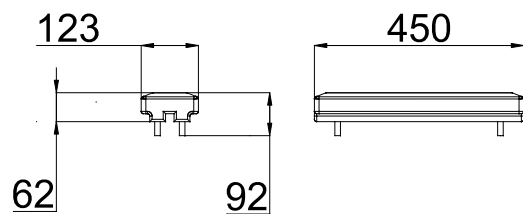

SYMBOLS

	Weight		Chart Wheels		Engine		Jib length and angle
	Counterweight		Minipicker		Diesel Fuel		Jib Length
	Crane		Back Wheel Point Loading		Gasoline Fuel		Jib Radius
	Travel Speed		Front wheel Point Loading		Tank		Hydraulic Jib Length
	Gradeability		Travel Speed		Battery		Hydraulic Jib Radius
	Outrigger Load		Gradeability		Power		Mechanical Jib Length
	Track Loading		Working Radius		Boom Angle		Mechanical Jib Radius
	Outriggers Setup		Hookblock		Boom Length		Manipulator Length
	Ext Tracks Width		Slewing		Boom Radius		Manipulator Radius
	Chart On Tracks		Slewing Locked		Jib Hook Radius		Maximum inclination of the machinery
	Jib on board		Without jib on board		Standard		Stabilizing bar
	Horizontal boom angle		Number of vacuum pads		Factory max. load		Building site max. load

Remarks referring to load chart

- The load charts are calculated according to EN 13000.
- For the calculation of the load charts at least a wind speed of 9m/s (33km/h) and regarding the load a sail area of 1m² per ton load and a wind resistance coefficient of 1.2 on the load have been taken into account. For lifting of loads with large sail areas and/or high wind resistance coefficients the maximum wind speed as stated in the load charts has to be reduced.
- Lifting capacities are given in kilograms.
- The weight of the hook blocks and hooks is part of the load and therefore it must be deducted from the lifting capacities.
- Working radii are measured from the slewing centre.
- The lifting capacities given for the telescopic boom apply if the folding jib is removed.
- Subject to modification of lifting capacities.

Blank area for notes.

Empty rectangular box for notes.

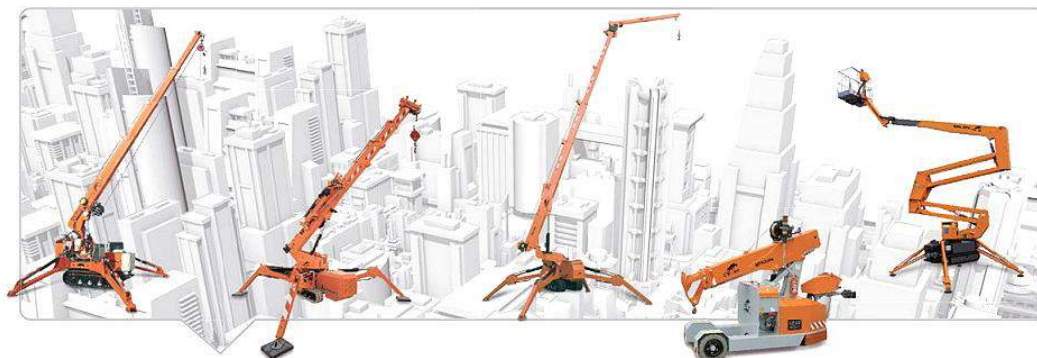

DEALER



JEKKO S.r.l. via Campardone, 1 Z.I. 31014 Colle Umberto (TV) Italy
tel. +39 0438 1710083 fax +39 0438 1710123
www.jekko.it - info@jekko.it